

CERACLAD SIDING PANEL (16mm)	INSTALLATION DETAIL	10FT COULKING JOINT PANEL	SDVC-G1
VERTICAL 9/16" (15mm)	STARTER BAR (STEEL STUD)		JAN 16 2013

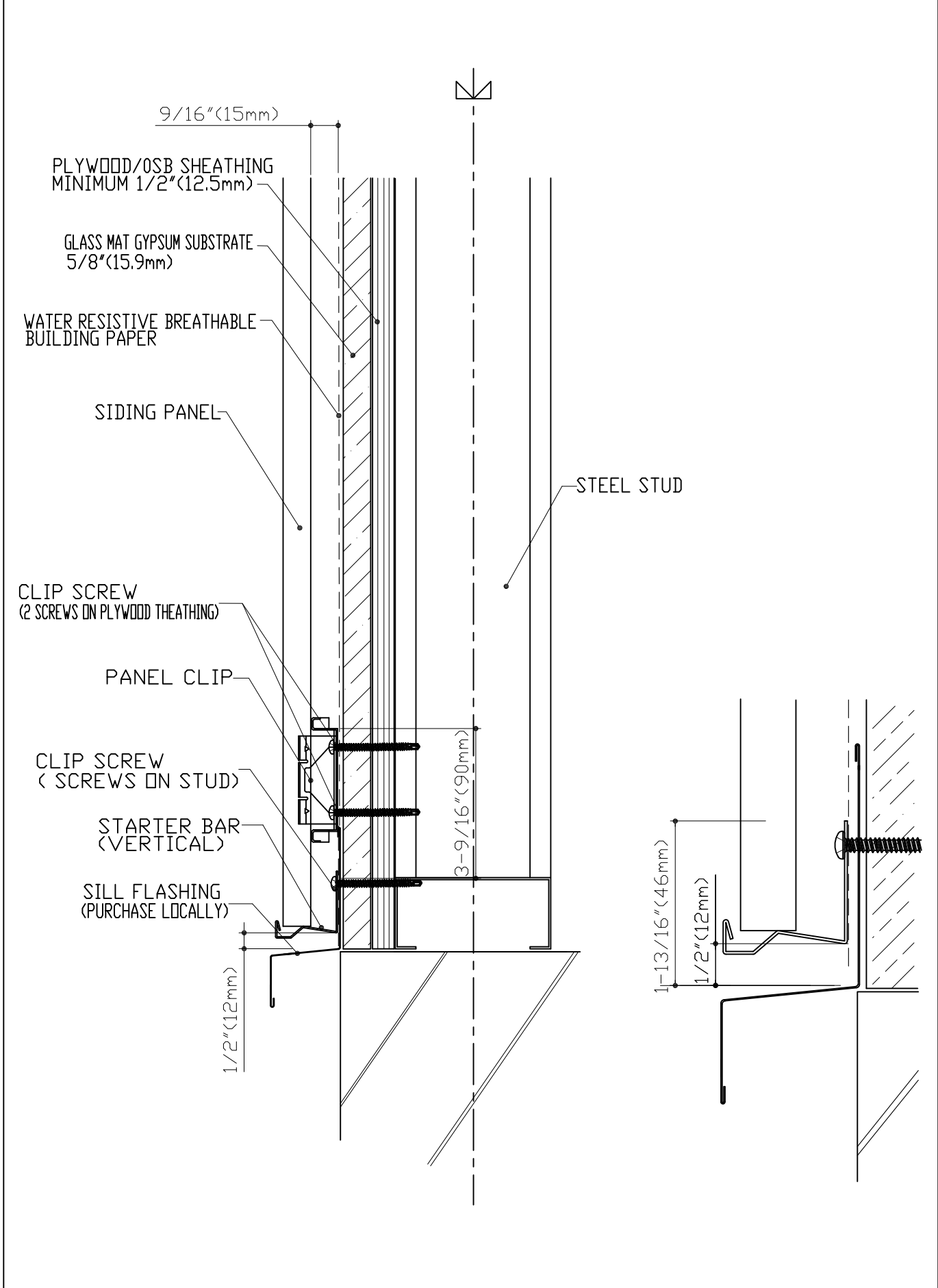

CERACLAD SIDING PANEL(16mm)	INSTALLATION DETAIL	10FT CAULKING JOINT PANEL	SDVC-VJ2
VERTICAL 9/16"(15mm)	PANEL VERTICAL JOINT(HORIZONTAL SECTION) (STEEL STUD)		MAY 30 2008

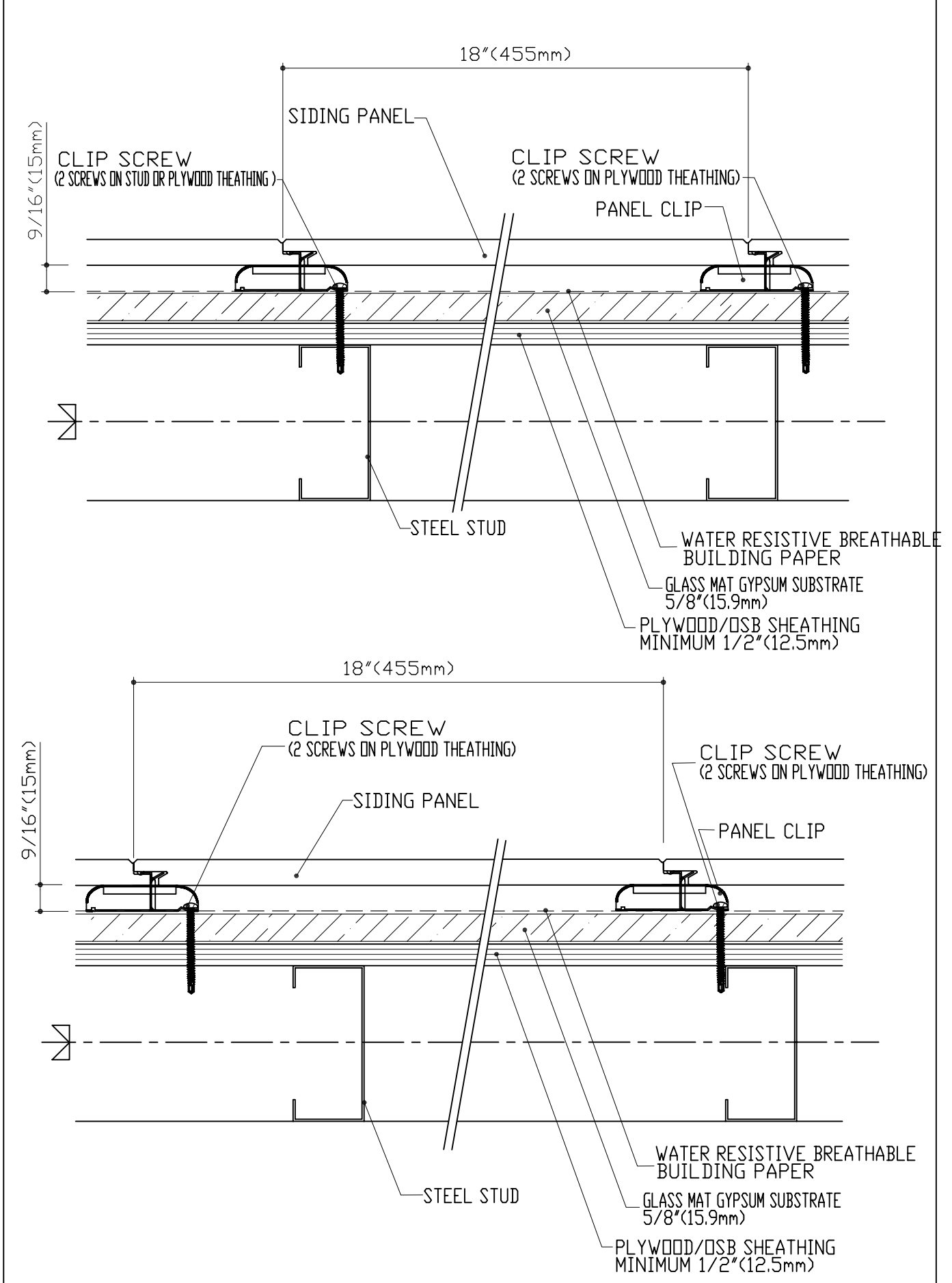

CERACLAD SIDING PANEL (16mm)	INSTALLATION DETAIL	10FT COULKING JOINT PANEL	SDVC-01
VERTICAL 9/16" (15mm)	OUT SIDE PREFORMED CORNER (STEEL STUD)		MAY 30 2008

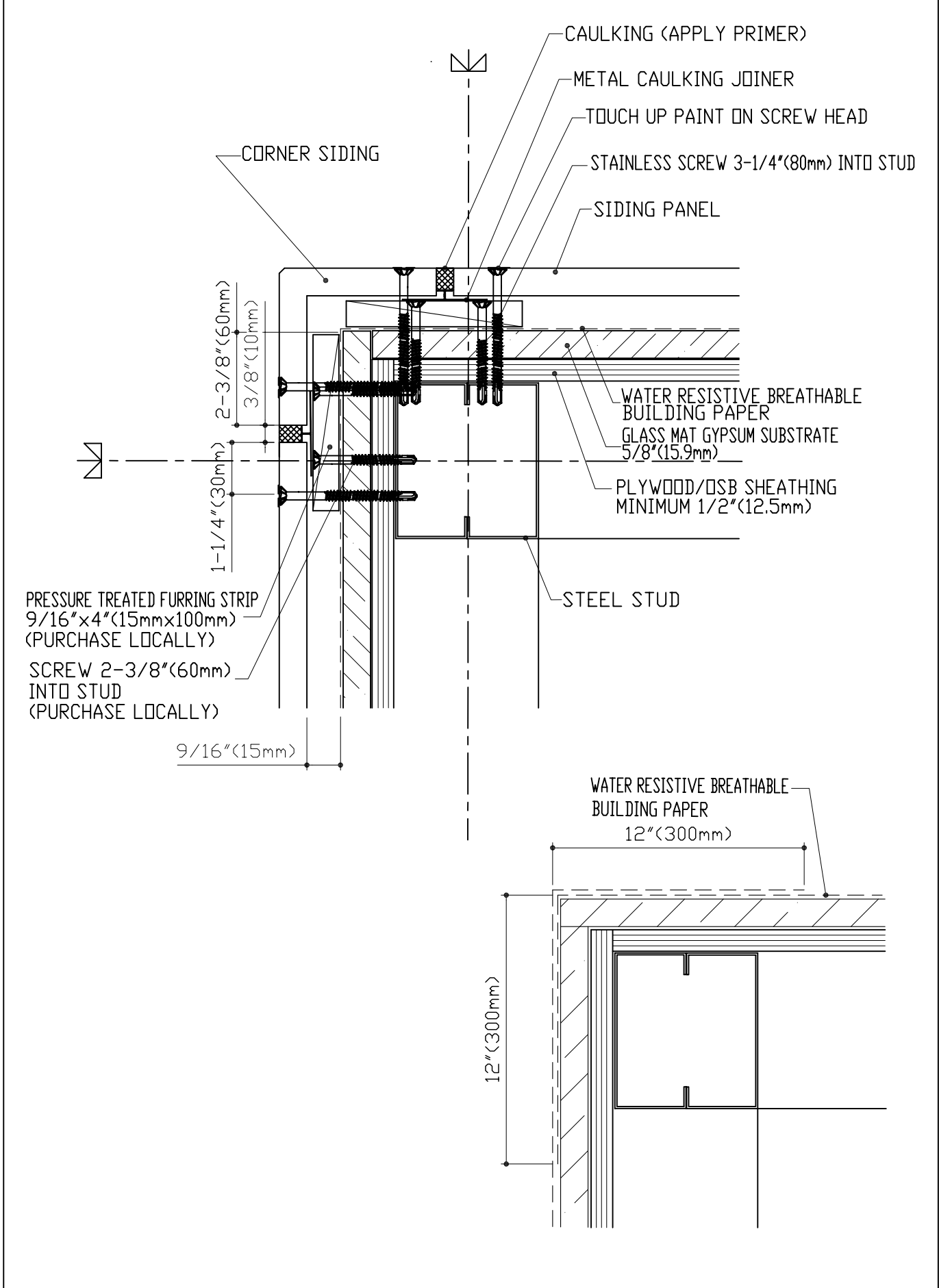

CERACLAD SIDING PANEL (16mm)	INSTALLATION DETAIL	10FT CAULKING JOINT PANEL	SDVC-I 1
VERTICAL 9/16" (15mm)	INSIDE CORNER (STEEL STUD)		MAY 29 2008

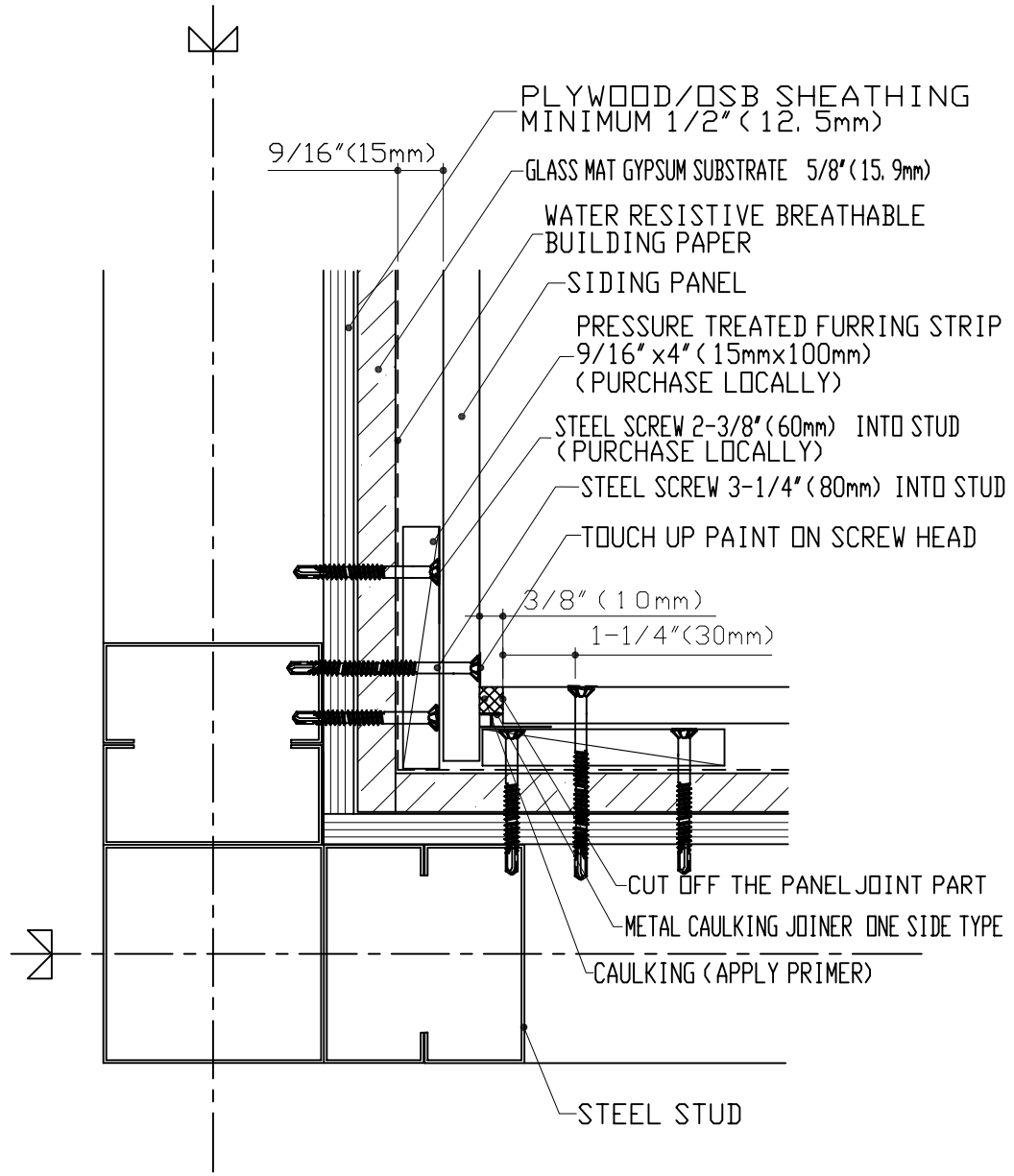
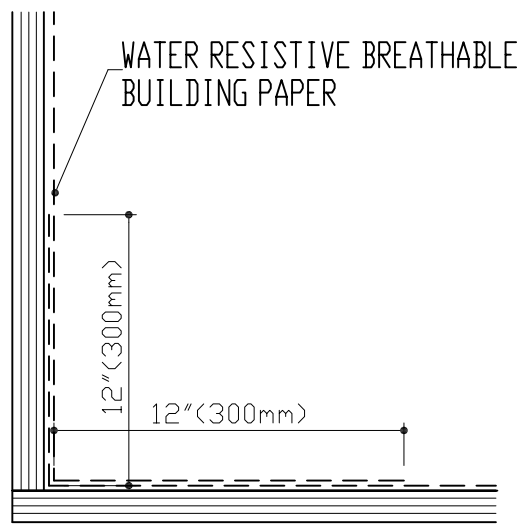

CERACLAD SIDING PANEL (16mm)	INSTALLATION DETAIL	10FT CAULKING JOINT PANEL	SDVC - S1
VERTICAL 9/16" (15mm)	UNDER EAVES (STEEL STUD)		MAY 30 2008

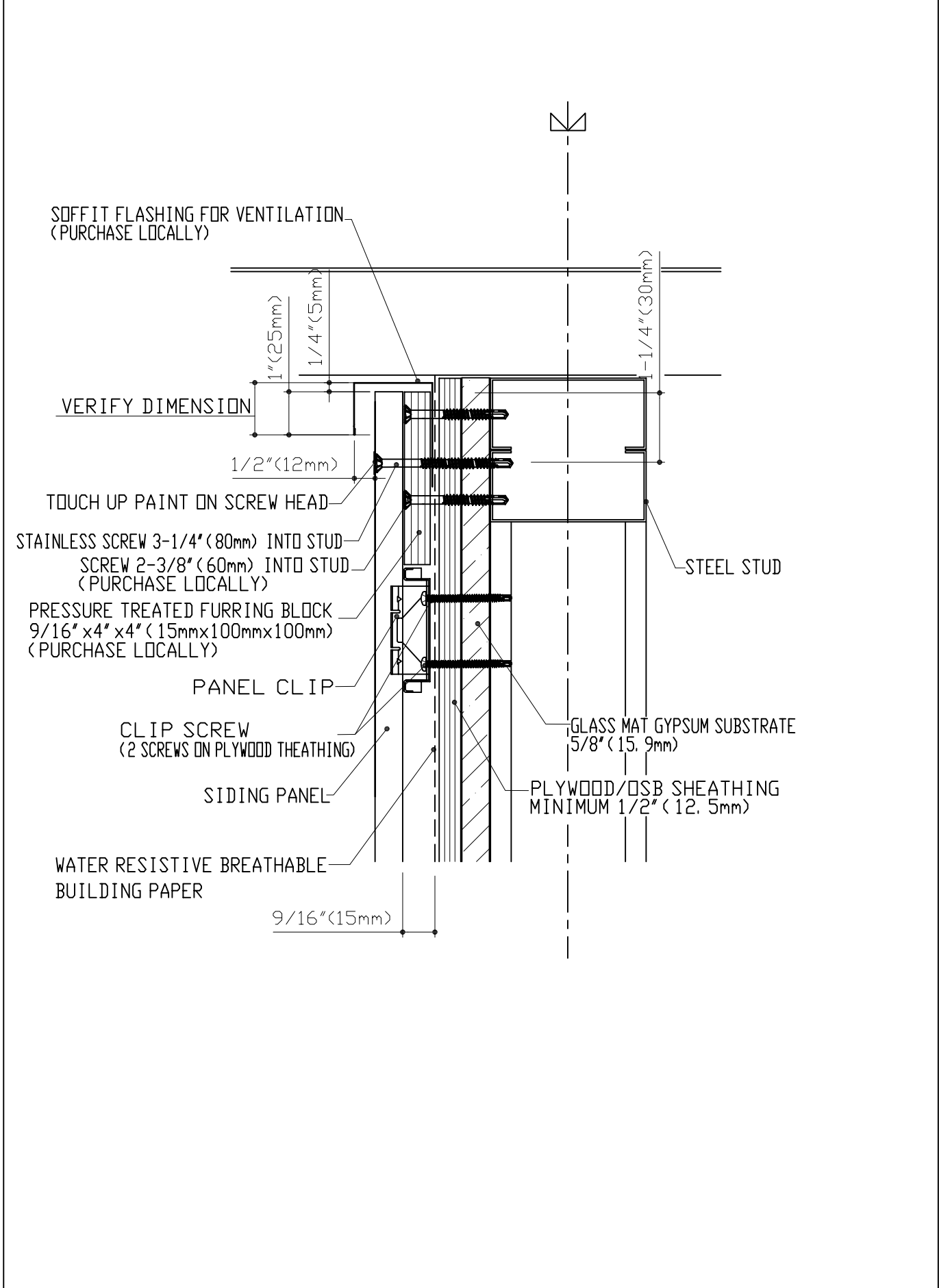

CERACLAD SIDING PANEL (16mm)	INSTALLATION DETAIL	10FT CAULKING JOINT PANEL	SDVC-M2
VERTICAL 9/16" (15mm)	THROUGH WALL FLASHING (STEEL STUD)		JAN 16 2013

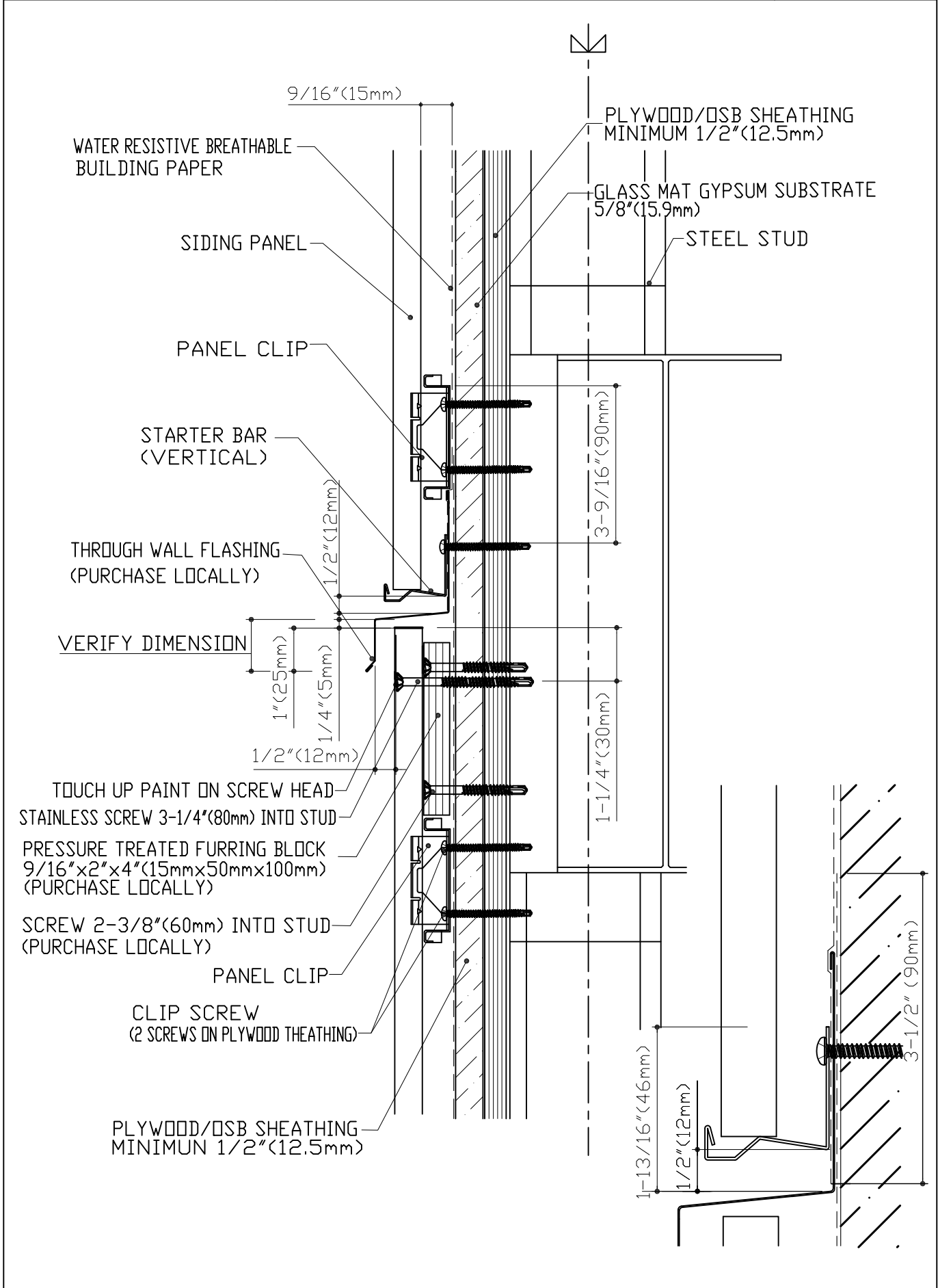

CERACLAD SIDING PANEL(16mm)	INSTALLATION DETAIL	10FT CAULKING JOINT PANEL	SDVC-WJ3
VERTICAL 9/16" (15mm)	WINDOW AND DOOR JAMB (CAULKING) (STEEL STUD)		OCT 28 ,2008

## VERIFY WINDOW DIMENSION

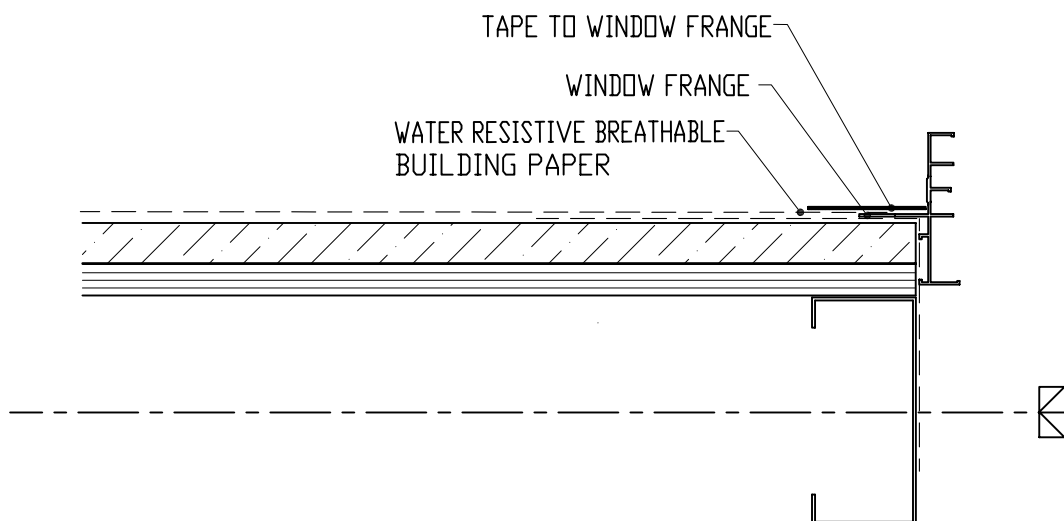
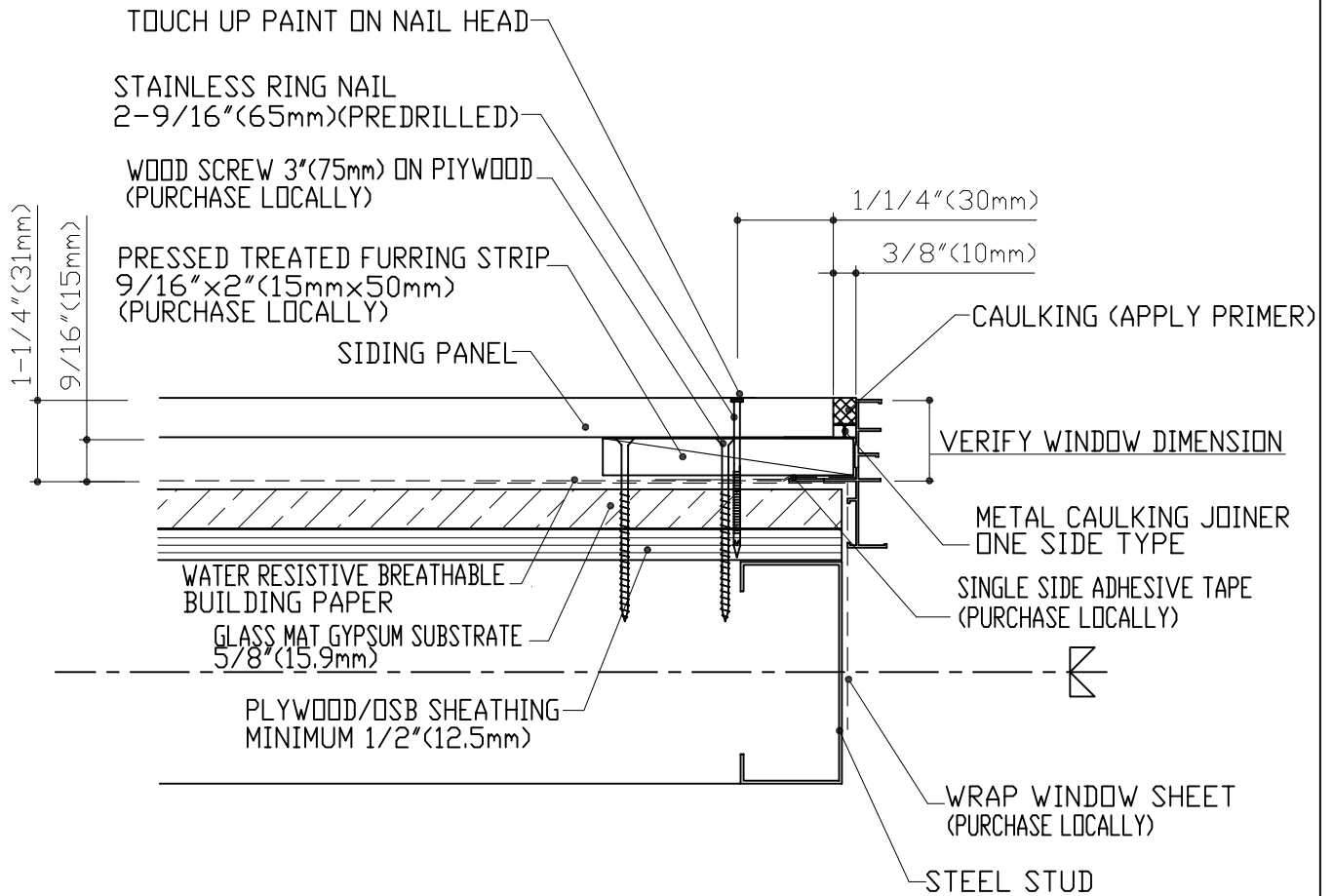

CERA CLAD SIDING PANEL (16mm)	INSTALLATION DETAIL	10FT CAULKING JOINT PANEL	SDVC-WS3
VERTICAL 9/16" (15mm)	WINDOW AND DOOR HEAD AND SILL (CAULKING) (STEEL STUD)		MARCH 28 2014

# VERIFY WINDOW DIMENSION

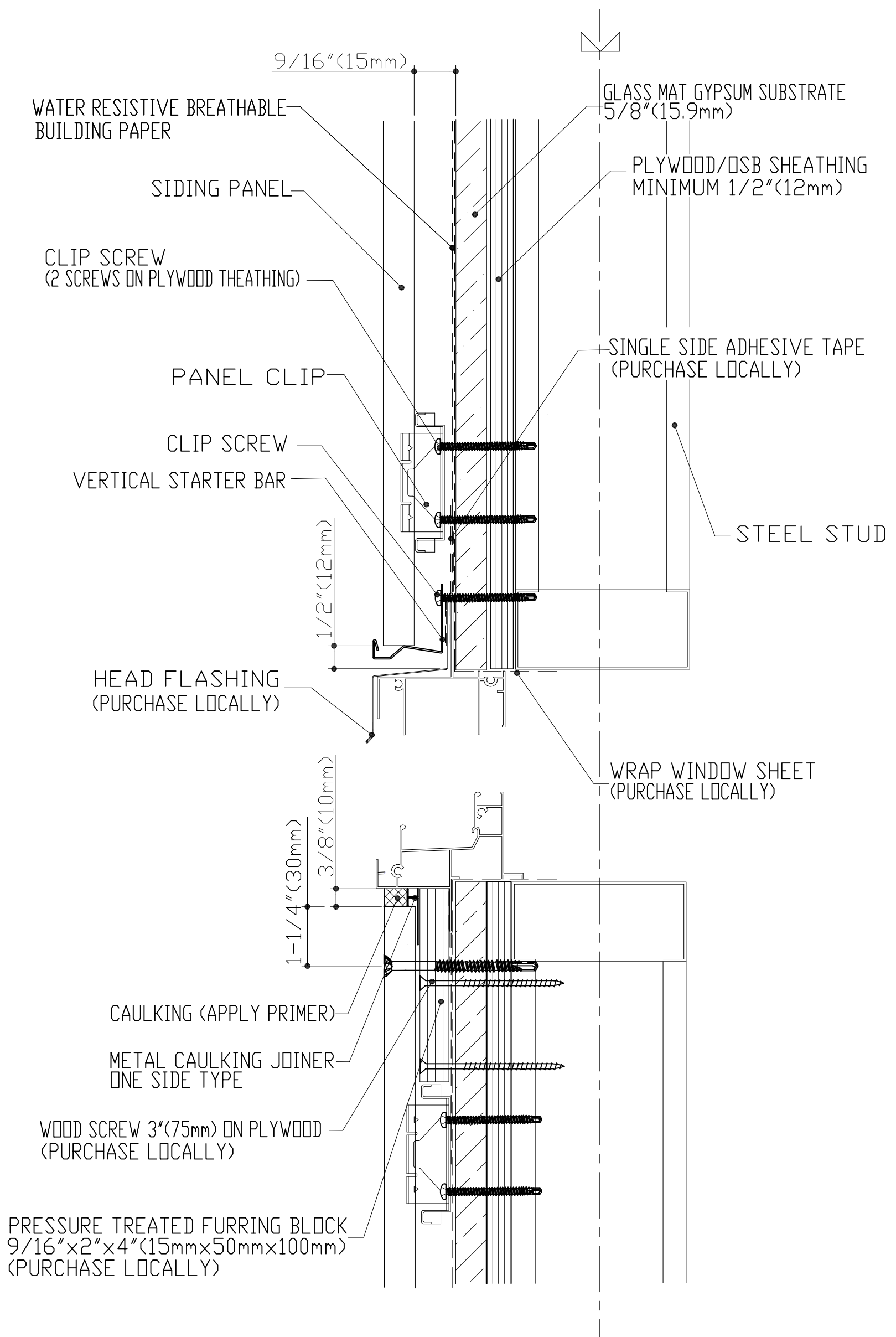



CERA CLAD SIDING PANEL (16mm)	INSTALLATION DETAIL	10FT CAULKING JOINT PANEL	SDVC-HL
VERTICAL 9/16" (15mm)	ROOF TO WALL (STEEL STUD)		MARCH 28 2014

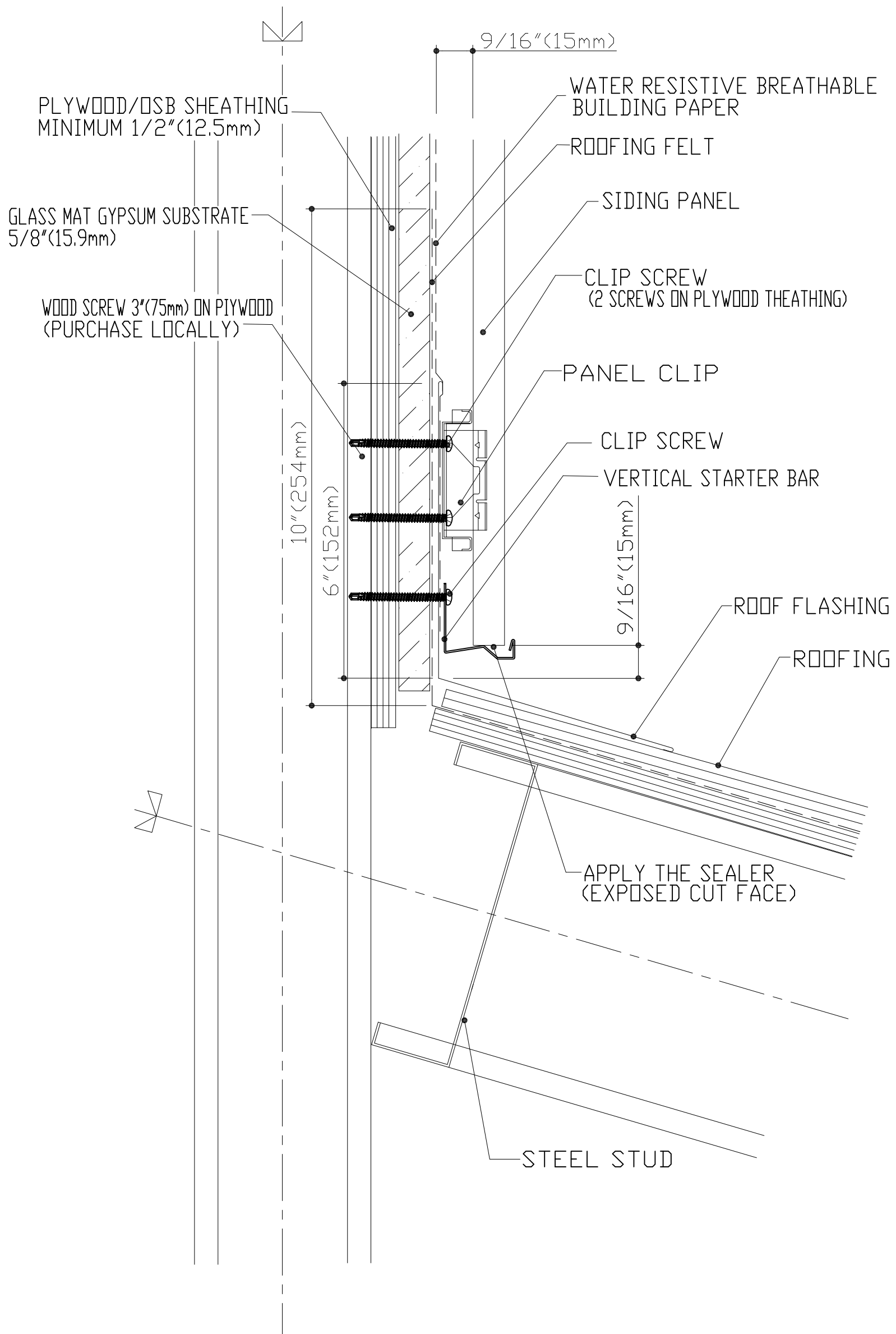

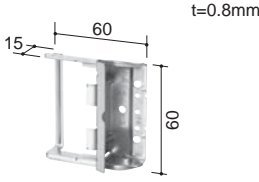
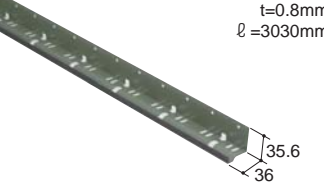

# 11. Vertical Application (Steel Structure / Glass Mat Gypsum) Details

## <1> Siding Panel Installation Accessories

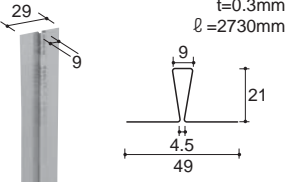
Clips for Rain Screen Exterior Siding System		
	Panel Clip	Starter Bar
Product No	B1015	B10157HG
Product		
Minimum Quantity to Order	30 pieces/bag 10 bags/box	10 pieces/box
Material	Galvanized Steel	Galvanized Steel

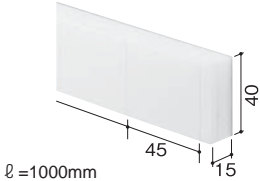
	Clip Screw	Stainless Screw	Metal Caulking Joiner
Product No	Purchase locally	Purchase locally	B272
Product	#8(4.2mm)×2-1/4"(55mm)	Please cover nail heads with touch-up paint after installation. #8(4.2mm)×3-1/4"(80mm)	
Minimum Quantity to Order			15 pieces/box
Material	Stainless Steel	Stainless Steel	Alloy Plated Steel

	Spacer Block	Repair Putty	Repair Paint
Product No	RY82S15	B4901	
Product			
Minimum Quantity to Order	22 blocks per strip 6 strips per box	1 piece	1 set/box
Material	Polypropylene		